



TYPE:  MODEL:   
PROJECT:

**PRODUCT FEATURES**



Material	Aluminum
Adjustment	Automatic Expansion
Dimensions	3" H x [ 24"   27"   30" ] DIA



**ORDERING INFORMATION**

EXAMPLE: TRM-3-B-AE-27-B12-ND

MODEL	JUNCTION BOX	FINISH	ADJUSTMENT	DIAMETER	HUB ENTRY	INPUT / DIM
TRM			AE		B12	

MODEL	JUNCTION BOX QTY	FINISH
TRM	<b>3</b> Three boxes 120° apart <b>4</b> Four boxes 90° apart	<b>B</b> Black
		<b>Z</b> Architectural Bronze
	<b>DZ</b> Dark Bronze	
	<b>GT</b> Granite	
	<b>W</b> White	
	<b>BR</b> Architectural Brick	
	<b>LZ</b> Light Bronze	
	<b>SB</b> Special Bronze	
	<b>GG</b> Glossy Gray	
	<b>R</b> Rust	
<b>HG</b> Hunter Green		
<b>WB</b> Weathered Bronze		
<b>WI</b> Weathered Iron		
<b>GM</b> Graphite Metallic		
<b>G</b> Verde		
<b>P</b> Pewter		
<b>M</b> Mocha		
<b>OF</b> Olde Finish		

ADJUSTMENT	TREE RING DIAMETER	ELECTRICAL HUB ENTRY	INPUT / DIMMING	ORDERING NOTES
<b>AE</b> Automatic Expansion	<b>24</b> 24 inch (Tree Diameter Range: 8" – 12")	<b>B12</b> NPT ½" – 14 bottom *	<b>LV</b> 2 Conductor cabling (Low Voltage)	* Only one junction box will have a bottom hub entry  Manual Adjustment option available. See <b>TRM-MA</b> specification.
	<b>27</b> 27 inch (Tree Diameter Range: 10" – 14")		<b>ND</b> 3 Conductor cabling (Line Voltage)	
	<b>30</b> 30 inch (Tree Diameter Range: 13" – 17")		<b>010</b> 5 Conductor cabling (Line Voltage)	





## SPECIFICATIONS

### DESCRIPTION:

Tree Ring Mount accommodates tree ring diameters from 8" to 17", and the mounting of up to four flood lights. The Automatic expansion feature allows for 2" of tree diameter growth without the need to manually adjust. The Tree Ring Mount is suitable for wet locations.

### JUNCTION BOX CONSTRUCTION:

Die-cast A360 aluminum. Door is stamped 5052-H32 aluminum.

### STRAP CONSTRUCTION:

1/8" thick x 3" wide affixed to each Junction Box with stainless steel fasteners. Strap is hinged and held with two 1/2" diameter stainless steel bolts. Hinge bolts are retained with stainless steel/nylon locking hex nuts. Hinged strap allows for easy installation around trees.

### FINISH:

Powder coat finish available in Black, Architectural Bronze, Dark Bronze, Granite, White, Architectural Brick, Light Bronze, Special Bronze, Glossy Gray, Rust, Hunter Green, Weathered Bronze, Weathered Iron, Graphite Metallic, Verde, Pewter, Mocha and Olde Finish. Custom Powder coat finishes available on request.

### ELECTRICAL SUPPLY:

One NPT 1/2"-14 bottom hub opening available for connection of flexible, outdoor rated conduit.

### WIRING:

- 18/3 SEOOO outdoor rated waterproof cable [for Non-dimmable and Phase Cut (TRIAC/ELV-120VAC only) options]
- 18/5 SJTOW outdoor rated waterproof cable [for 0-10V dimming option]

### TREE CLAMPING:

Tree clamp features an automatic expansion that can adjust up to 2" in diameter to accommodate tree growth. This adjustment feature uses 3/8" stainless steel threaded rod with a 1 1/2" diameter machined clamp foot to affix to the tree. The clamp foot is designed to securely affix the Tree Ring Mount to the tree with minimum damage to the bark.

### LOAD RATING:

- TRM-3: Maximum load of 6 pounds per junction box.
- TRM-4: Maximum load of 5.5 pounds per junction box.

Tested to UL 1598/CSA C22 No. 250.0 Standard.

### CERTIFICATION:

cULus wet location listed.

## JUNCTION BOX VARIATIONS

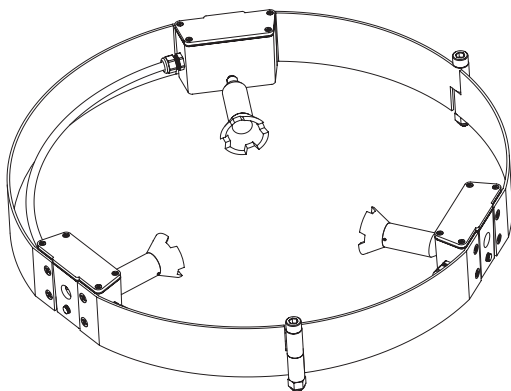

**TRM-3** Automatic Expansion

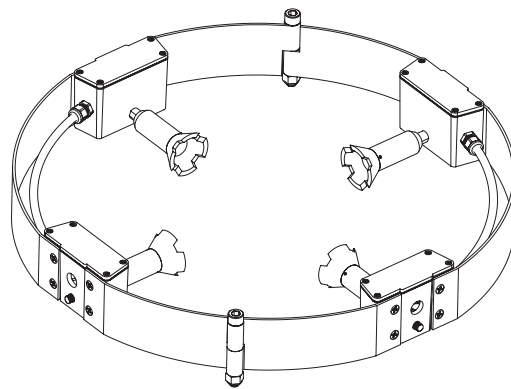

**TRM-4** Automatic Expansion





THREE BOX AE DIMENSIONS

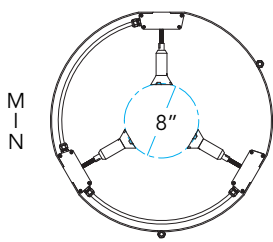

24"

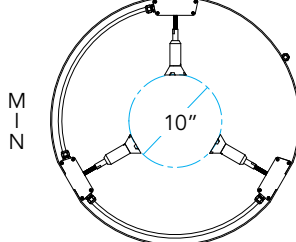

27"

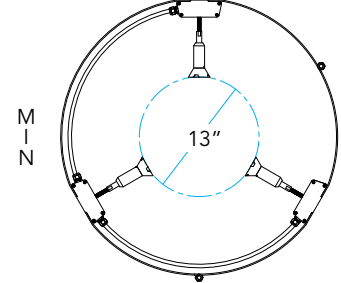

30"

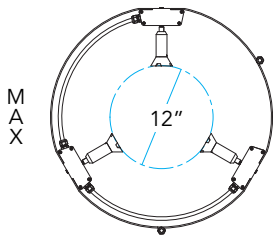

12"

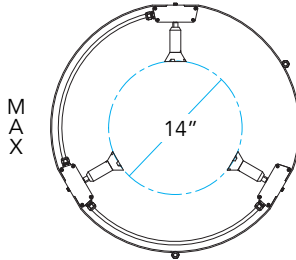

14"

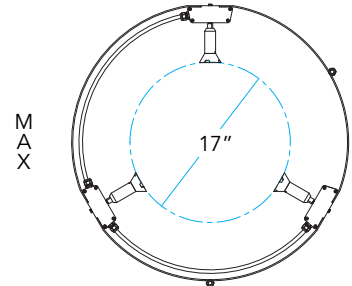

17"

FOUR BOX AE DIMENSIONS

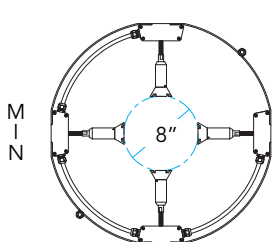

24"

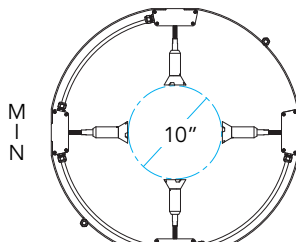

27"

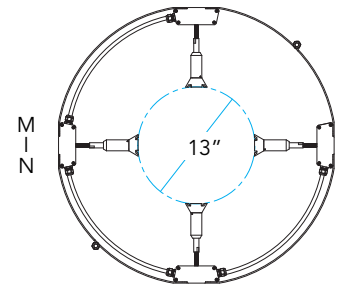

30"

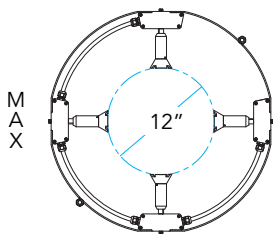

12"

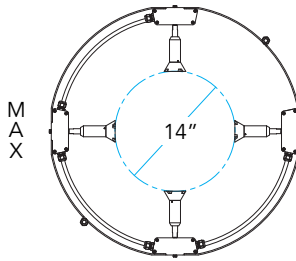

14"

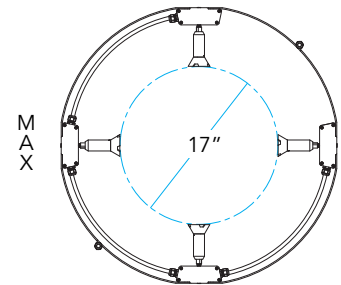

17"

