



WARNING: Luminaire must be installed and grounded in accordance with the National Electrical Code (NEC) and local codes. For portable stake or surface mount using a cord and plug, the luminaire must be plugged into a receptacle protected by a ground fault circuit interrupter (GFI). Failure to do so may result in serious injury and/or damage to the luminaire.

MAINTENANCE: To assure proper operation and efficiency and to prevent luminaire overheating, lens must be kept clean and free of dirt, dust, leaves, trash and mineral deposits from water. A regular schedule maintenance program is recommended.

SAFETY WARNING: Luminaire can become hot depending on lamp wattage. Lens and housing around lamp can become hot enough to blister hands. Particular care should be taken not to locate luminaires where small children can reach them if high wattage lamps are used.

NOTE: Always use UL recognized wire connectors for connections.

LUMINAIRE IS UL LISTED FOR ABOVE GRADE INSTALLATION ONLY.



LUMINAIRE MOUNTING

1. Make sure electrical supply is off at circuit breaker before starting luminaire installation or servicing luminaire.
2. Thread luminaire onto junction box or other mounting device until it is at desired direction using thread sealant. Tighten jam nut (provided) to ensure the luminaire is locked to adjusted position.
3. Attach luminaire leads to line in leads observing polarity, black to black, white to white and green to ground using silicone filled safety connectors (provided).
4. Attach junction box cover with luminaire to junction box (by others). Make sure not to pinch wires that may be sandwiched between cover and box.
5. Coat exposed luminaire threads with thread sealant to keep moisture from entering junction box or other mounting device.
6. To adjust luminaire aiming angle, loosen adjustable knuckle screw. Do not disengage totally. Hold luminaire at selected angle and tighten knuckle screw firmly.
7. Install lamp.
8. Coat all exposed screws with silicone grease.
9. Supply power to the luminaire and check for proper operation.

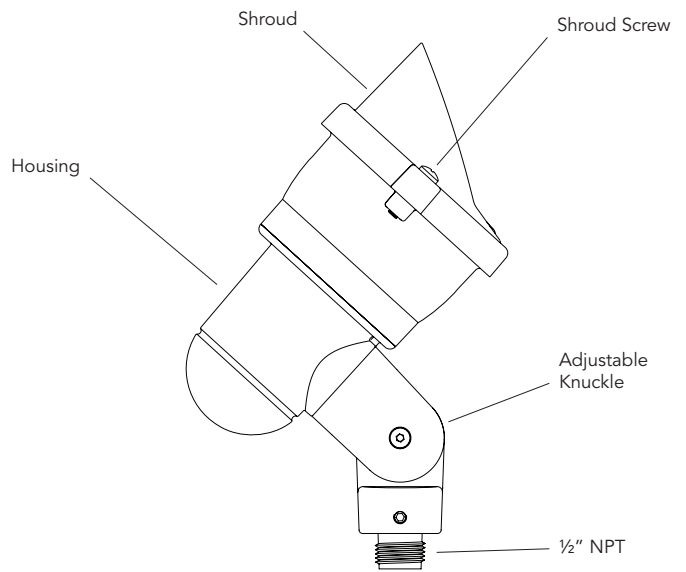

WARNING: TO REDUCE THE RISK OF FIRE, OR INJURY TO PERSONS:

1. Turn off/unplug and allow to cool before replacing lamp.
2. Lamps get hot quickly! Contact only switch/plug when turning on.
3. Do not touch hot lens, guard or enclosure.
4. Keep lamp away from material that may burn.
5. Do not touch the lamp at any time. Use a soft cloth. Oil from the skin may damage lamp.
6. Do not operate luminaire fitting with a missing or damaged cover.

LED LAMP INSTALLATION/REPLACEMENT:

- CAUTION:** Do not exceed maximum wattage marked on luminaire label.
1. To prevent electrical shock, disconnect from electrical supply before service.
 2. Loosen screw from shroud.
 3. Remove shroud and gasket to expose lamp.
 4. Replace lamp with correct wattage and type marked on fixture label.

NOTE: DO NOT touch lamp with bare hands. Always use soft cloth or the plastic wrapping (if available) to handle the lamp.

5. Re-install shroud and gasket and tighten shroud screws.

Lamp Information		
Model	Lamp Type	Max Wattage
1080	MR-16	50

Vista Professional Outdoor Lighting reserves the right to modify the design and/or construction of the fixture shown without further notification.

