

Type: _____
 Model: _____
 Project: _____

SPECIFICATION SHEET

MODEL: 2147 - 12V Brass & Copper Series: Step & Brick Lights

FIXTURE SPECIFICATIONS:

HOUSING:

Injection-molded, glass-reinforced Ryton® R-4 composite for strength & high UV stability – warranted for ten years against corrosion. Cover plate is fitted to recessed box with a silicone O-ring gasket – providing a superior weather-tight seal.

COVER PLATE:

Precision CNC-machined solid brass faceplate, fitted to housing with a silicone O-ring gasketed lens – providing a superior weather-tight seal.

FINISH:

Brushed Natural Brass, Olde Brass, or Stainless Steel.

SOCKET/LAMP HOLDER:

Top grade ceramic socket with nickel contacts, stainless steel springs, & Teflon-jacketed wire leads.

LENS:

Frosted, tempered, shock & heat-resistant, soda-lime glass lens - crowned (convex) to increase beam spread.

LAMP TYPE:

MR-16 Halogen – 35W maximum. LN-20 BAB (20W) Standard (See back page for LED lamp specifications).

OPTICS/AIMING:

Adjustable lamp bracket (not available with LED) provides up to ±25°

of tilt for precise beam control. Lamp bracket can be locked into place to prevent disrupting lamp position when relamping.

MOUNTING:

Recessed mounting box has two ½" NPT inlets. Optional concrete mounting kit available, please see accessories column on fixture ordering information.

FASTENERS/INSERTS:

All fasteners are stainless steel with brass inserts.

WIRING:

Provided with a three-foot pigtail of 18-2 direct-burial cable & underground connectors for a secure connection to supply cable.

CERTIFICATION:

UL Listed to U.S. & Canadian safety standards for low voltage landscape luminaires (UL 1838). Maximum wattages allowed by Underwriters Laboratories (UL) for U.S. & Canadian markets may vary. Maximum wattages specified are Underwriters Laboratories U.S. standard. Please contact Vista for any questions about maximum wattages allowed by UL Canadian standards.

All Vista luminaires are **MADE IN U.S.A.**

DIMENSIONS:

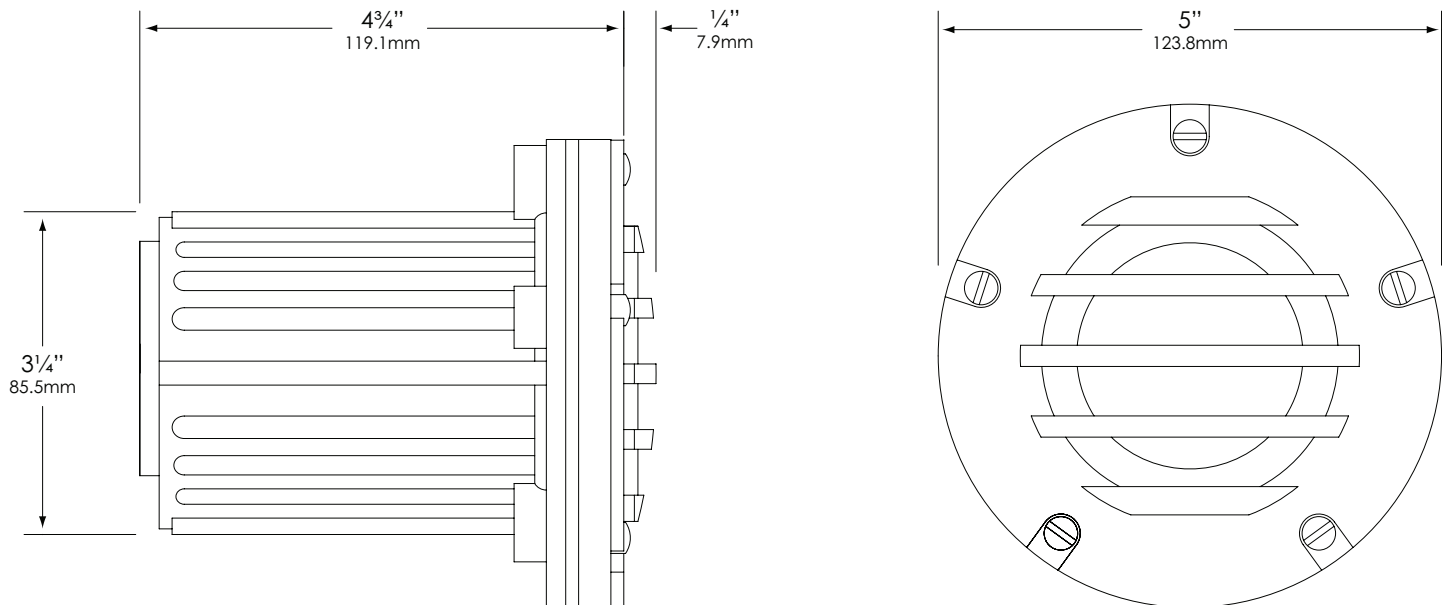

Vista Professional Outdoor Lighting reserves the right to modify the design and/or construction of the fixture shown without further notification.



SPECIFICATION SHEET

MODEL: 2147 - 12V Brass & Copper Series: Step & Brick Lights

LED LAMP SPECIFICATIONS (if applicable) :

LAMP TYPE:

High Output LED with Vista exclusive smart-driver, powered to operate for 50,000 hours.

ELECTRICAL:

Input voltage range 6 - 15V AC or 12V DC, regulated to achieve uniform illumination throughout the cable run of fixtures. Integral surge & reverse polarity protection.

FIXTURE ORDERING INFORMATION

TO ORDER FIXTURE: Select appropriate choice from each column as in the following example

EXAMPLE: SL-2147-BSN-BAB-CBL

MOUNTING	MODEL	FINISH	LAMP	ACCESSORIES
SL- Step light	2147	BSN - Natural Brass BSO - Olde Brass SS - Stainless Steel	MR-16 Halogen 35W maximum LN-20 BAB (20W) Standard LED - Group C Emitter Qty - 3 Temperature - Warm (W), Neutral (N), Cool (C) Operating voltage range - 6 to 15V. <i>(Please see lamp order code column on lamp guide, Vista product catalog.)</i>	CBL - Crowned Blue Lens DBL - Dark Blue Lens SL - Spread Lens GL - Dark Green Lens RL - Red Lens YL - Amber Lens HL - Honeycomb Louver

Fixtures shipped with standard lamp, unless otherwise specified.

Vista Professional Outdoor Lighting reserves the right to modify the design and/or construction of the fixture shown without further notification.