



**VISTA
PROFESSIONAL
OUTDOOR
LIGHTING**

Type: _____

Model: _____

Project: _____

SPECIFICATION SHEET

MODEL: 5221 - 12V SERIES: Step & Brick Lights

SPECIFICATIONS:

HOUSING:

Injection-molded, glass-reinforced Ryton® R-4 composite for strength & high UV stability – warranted for ten years against corrosion. The cover plate is fitted to the recessed box with a silicone o-ring gasket – providing a superior weather-tight seal.

FINISH:

Available in Black, Verde, Architectural Brick, Light Bronze, Dark Bronze, Granite, Terra-cotta, Rust, Hunter Green, Mocha, Weathered Bronze, Weathered Iron, and White.

SOCKET/LAMP HOLDER:

Top grade ceramic socket with nickel contacts, stainless steel springs, & Teflon-jacketed wire leads.

LENS:

Frosted, tempered, shock & heat-resistant, soda-lime glass lens - crowned (convex) to increase beam spread.

LAMP TYPE:

MR-16 Halogen – 35W maximum. LN-20 BAB (20W) Standard.

(See back page for LED lamp specifications)

MOUNTING:

Recessed mounting box has two ½" NPT inlets. Optional concrete mounting kit available, please see accessories column on fixture ordering information.

FASTENERS/INSERTS:

All fasteners are stainless steel with brass inserts.

WIRING:

Provided with a three-foot pigtail of 18-2 direct-burial cable & underground connectors for a secure connection to the supply cable.

CERTIFICATION:

UL Listed to U.S. & Canadian safety standards for low voltage landscape luminaires (UL 1838). The maximum wattages allowed by Underwriters Laboratories (UL) for the U.S. & Canadian markets may vary. Maximum wattages specified are Underwriters Laboratories U.S. standard. Please contact Vista for any questions about the maximum wattages allowed by UL Canadian standards.

All Vista luminaires are **MADE IN THE U.S.A.**

DIMENSIONS:

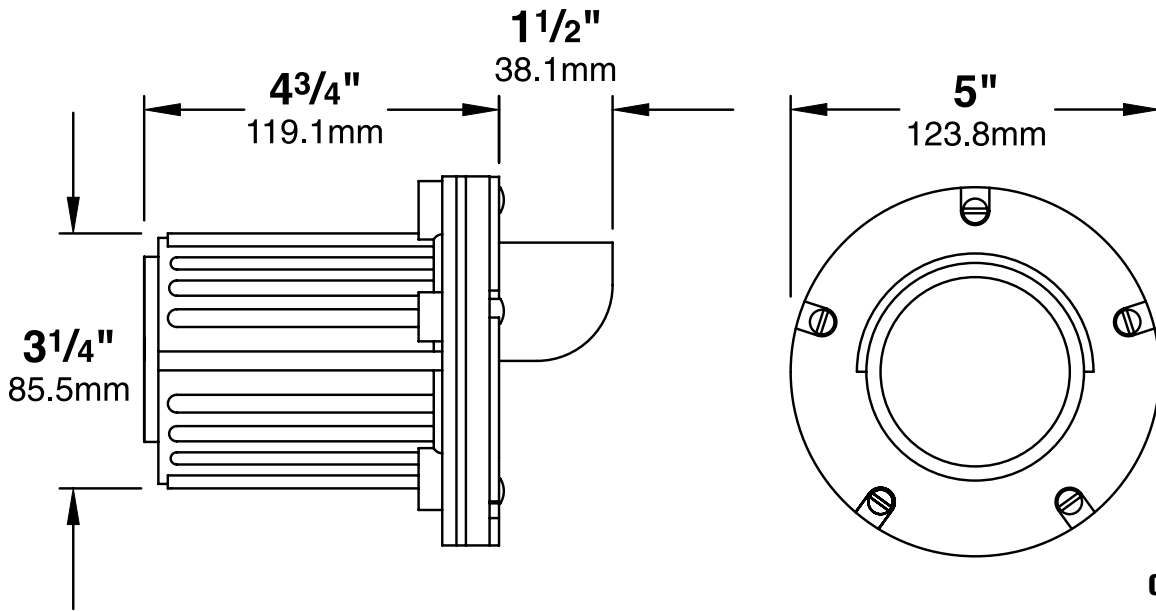

In an effort to improve product design U.S.T.E., Inc. reserves the right to modify the specifications of this fixture.



LED LAMP SPECIFICATIONS (if applicable) :

LAMP TYPE:

Lumiled Rebel High Output LED with Vista exclusive smart-driver, powered to operate for 50,000 hours.

OPTICS:

Integral high-efficiency optics available in spot through flood beam spreads.

ELECTRICAL:

Input voltage range 6–15V AC, regulated to achieve uniform illumination throughout the cable run of fixtures. Integral surge & reverse polarity protection.

FIXTURE ORDERING INFORMATION

TO ORDER FIXTURE: Select appropriate choice from each column as in the following example

EXAMPLE: SL-5221-B-BAB-BL

MOUNTING	MODEL	FINISH	LAMP	ACCESSORIES
SL- Step light	5221	B - Black G - Verde BR - Architectural Brick LZ - light Bronze DZ - Dark Bronze GT - Granite TC - Terra-cotta R - Rust HG - Hunter Green M - Mocha WB - Weathered Bronze WI - Weathered Iron W - White	(Please see lamp order code column on lamp guide, Vista product catalog.)	CBL - Crowned Cool Blue lens SL - Flat Spread lens DBL - Flat Dark Blue lens GL - Flat Dark Green lens RL - Flat Red lens YL - Flat Amber lens HL - Honeycomb louver JBCP-150 - Concrete mounting kit

Fixtures shipped with standard lamp, unless otherwise specified.