

SPECIFICATION SHEET

MODEL: 5271 - 12V Series: In-Ground & Well Lights

FIXTURE SPECIFICATIONS:

HOUSING:

Injection-molded, glass-reinforced Ryton® R-4 composite for strength and high UV stability – warranted for ten years against corrosion.

LENS COVER:

Injection-molded, glass-reinforced Ryton® R-4 composite fitted to housing with a silicone O-ring gasket – providing a superior weather-tight seal.

FINISH:

Polyester powder-coat finish available in Black, Verde, Architectural Brick, Light Bronze, Dark Bronze, Granite, Pewter, Terra-cotta, Rust, Hunter Green, Mocha, Weathered Bronze, Weathered Iron, and White.

SOCKET/LAMP HOLDER:

Top grade ceramic socket with nickel contacts, stainless steel springs, and Teflon-jacketed wire leads.

LENS:

Clear, tempered, shock and heat-resistant, soda-lime glass lens- crowned (convex) to promote water runoff. Optical effect lenses are available; see accessories column on fixture ordering information chart.

LAMP TYPE:

MR-16 Halogen – 50W maximum. LN-20 BAB/FG (20W) Standard.

(See back page for LED lamp specifications)

OPTICS/AIMING:

Adjustable lamp bracket (not available with LED) provides up to ±25° of tilt as well as 360° rotation of housing for precise beam control. Lamp

bracket can be locked into place to prevent disrupting lamp position when relamping. Models with housing brackets within ABS wells provide up to ±45° of tilt in addition to lamp bracket.

MOUNTING:

In-grade. Conduit mount fixtures have two ¼" NPT inlets on bottom. Optional concrete mounting kit available; please see accessories column on fixture ordering information chart.

FASTENERS/INSERTS:

All fasteners are stainless steel with brass inserts.

WIRING:

Prewired with a three-foot pigtail of 18-2 direct-burial cable and underground connectors for a secure connection to supply cable.

CERTIFICATION:

UL Listed to U.S. and Canadian safety standards for low voltage landscape luminaires (UL 1838). Maximum wattages allowed by Underwriters Laboratories (UL) for U.S. and Canadian markets may vary. Maximum wattages specified are Underwriters Laboratories U.S. standard. Please contact Vista for any questions about maximum wattages allowed by UL Canadian standards. This luminaire has an ingress protection rating of **IP67** for protection against detrimental dust intrusion as well as penetration of water under submersion.

All Vista luminaires are **MADE IN U.S.A.**

DIMENSIONS:

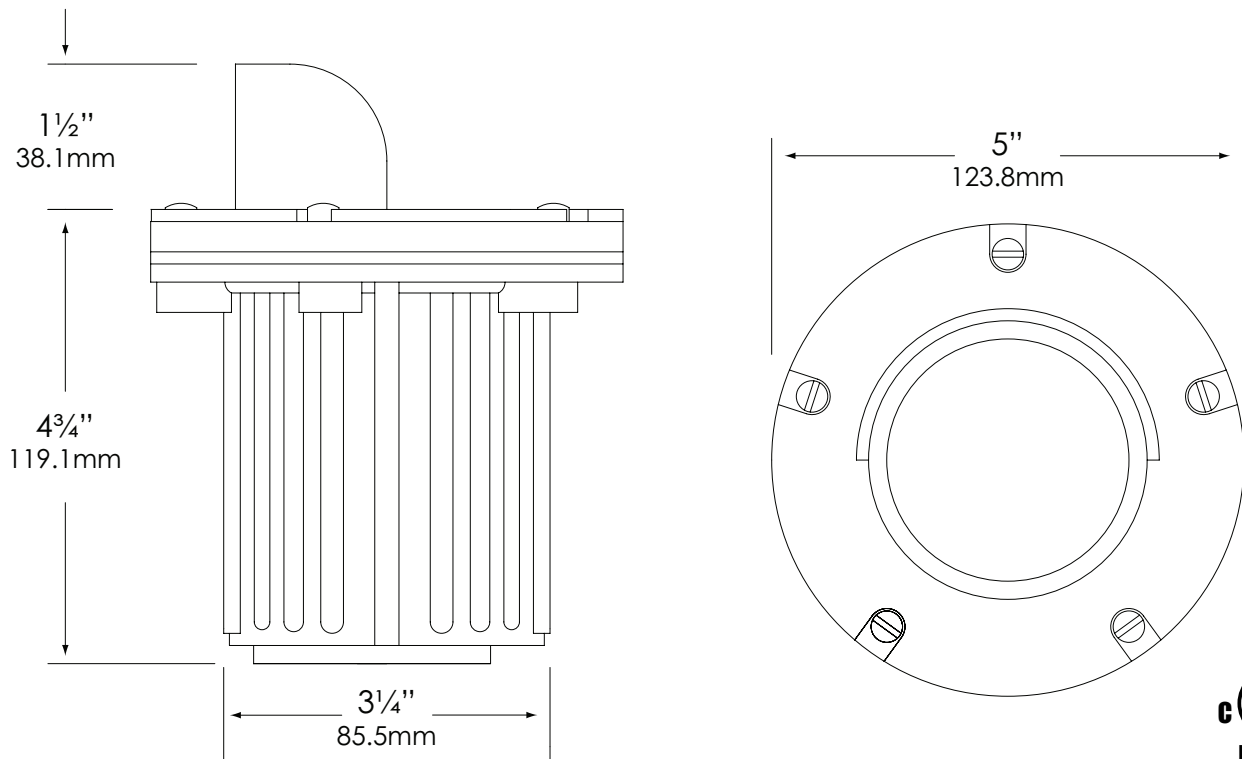

Vista Professional Outdoor Lighting reserves the right to modify the design and/or construction of the fixture shown without further notification.

SPECIFICATION SHEET

MODEL: 5271 - 12V Series: In-Ground & Well Lights

LED LAMP SPECIFICATIONS (if applicable) :

LAMP TYPE:

High Output LED with Vista exclusive smart-driver, powered to operate for 50,000 hours.

OPTICS:

Integral high-efficiency optics available in spot through flood beam spreads.

ELECTRICAL:

Input voltage range 5-15V AC, regulated to achieve uniform illumination throughout the cable run of fixtures. Integral surge & reverse polarity protection.

FIXTURE ORDERING INFORMATION

TO ORDER FIXTURE: Select appropriate choice from each column as in the following example

EXAMPLE: GW-5271-B-BAB-HL

MOUNTING	MODEL	FINISH	LAMP/LED	ACCESSORIES
GW - In-grade CM - In-grade conduit mount	5271	B - Black G - Verde BR - Architectural Brick LZ - Light Bronze DZ - Dark Bronze GT - Granite P - Pewter TC - Terra-cotta R - Rust HG - Hunter Green M - Mocha WB - Weathered Bronze WI - Weathered Iron W - White	MR-16 Halogen 50W maximum LN-20 BAB/FG (20W) Standard LED - Group A Emitter Qty - 3 Distribution - Spot (SP), Flood (FL) or Wide Flood (WF) Temperature - Neutral (N) Operating voltage range - 6 to 15V. <i>(Please see lamp order code column on lamp guide, Vista product catalog.)</i>	BL - Flat Cool Blue lens CBL - Crowned Cool Blue lens CFR - Crowned Frosted lens SL - Flat Spread lens DBL - Flat Dark Blue lens GL - Flat Dark Green lens RL - Flat Red lens YL - Flat Amber lens HL - Honeycomb louver JBCP-150 - Concrete Mounting Kit

Fixtures shipped with standard lamp, unless otherwise specified.