

Type: _____
 Model: _____
 Project: _____

SPECIFICATION SHEET

MODEL: 8227 - 12V Series: Bollards & Beacons

FIXTURE SPECIFICATIONS:

HOUSING:

Die-cast, copper-free aluminum with a silicone gasket to provide a superior weather-tight seal.

POST:

Heavy-gauge extruded aluminum (1/8" wall thickness).

FINISH:

Polyester powder-coat finish available in Black, Verde, Architectural Brick, Architectural Bronze, Light Bronze, Dark Bronze, Granite, Pewter, Terra-cotta, Rust, Hunter Green, Mocha, Weathered Bronze, Weathered Iron, and White.

SOCKET/LAMP HOLDER:

Top grade ceramic socket with nickel contacts, stainless steel springs, and Teflon-jacketed wire leads.

LENS:

Clear, prismatic, high-impact, polycarbonate lens.

LAMP TYPE:

T3 – 20W maximum. LN-10 T3 Halogen (10W) Standard.

(See back page for LED lamp specifications)

OPTICS/AIMING:

Adjustable lamp bracket provides up to ±25° of tilt for precise beam control. Lamp bracket can be locked into place to prevent disrupting lamp position when relamping.

MOUNTING:

Aluminum mounting base included. Non-corroding ABS ground stake for ground mounting and foundation anchor rods for permanent cement installation also provided.

FASTENERS:

All fasteners are stainless steel.

WIRING:

Provided with a three-foot pigtail of 18-2 direct-burial cable and underground connectors for a secure connection to the supply cable.

CERTIFICATION:

UL Listed to U.S. and Canadian safety standards for low voltage landscape luminaires (UL 1838). The maximum wattages allowed by Underwriters Laboratories (UL) for the U.S. and Canadian markets may vary. Maximum wattages specified are Underwriters Laboratories U.S. standard. Please contact Vista for any questions about the maximum wattages allowed by UL Canadian standards.

All Vista luminaires are **MADE IN THE U.S.A.**

DIMENSIONS:

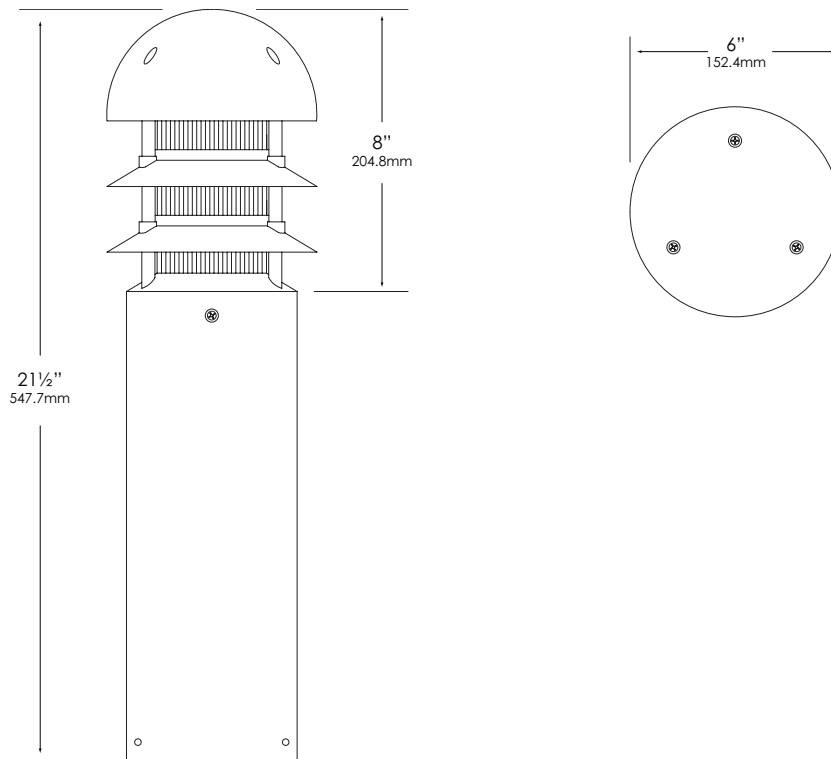

Vista Professional Outdoor Lighting reserves the right to modify the design and/or construction of the fixture shown without further notification.



SPECIFICATION SHEET

MODEL: 8227 - 12V Series: Bollards & Beacons

LED LAMP SPECIFICATIONS (if applicable) :

LAMP TYPE:

High Output LED with Vista exclusive smart-driver, powered to operate for 50,000 hours.

OPTICS:

Integral high-efficiency optics available in spot through flood beam spreads.

ELECTRICAL:

Input voltage range 6 - 15V AC, regulated to achieve uniform illumination throughout the cable run of fixtures. Integral surge & reverse polarity protection.

FIXTURE ORDERING INFORMATION

TO ORDER FIXTURE: Select appropriate choice from each column as in the following example

EXAMPLE: BR-8227-B-10 T3

MOUNTING	MODEL	FINISH	LAMP	ACCESSORIES
BR- Ground & Concrete Mounting Kit	8227	B - Black G - Verde BR - Architectural Brick Z - Architectural Bronze LZ - Light Bronze DZ - Dark Bronze GT - Granite P - Pewter TC - Terra-cotta R - Rust HG - Hunter Green M - Mocha WB - Weathered Bronze WI - Weathered Iron W - White	T3 Halogen 20W maximum LN-10 T3 Halogen (10W) Standard LED - Group C Emitter Qty - 3 Temperature - Warm (W), Neutral (N), Cool (C) Operating voltage range - 6 to 15V. <i>(Please see lamp order code column on lamp guide, Vista product catalog.)</i>	RS - 180° reflector shield

Fixtures shipped with standard lamp, unless otherwise specified.

Fixtures shipped with specified mounting hardware.

Vista Professional Outdoor Lighting reserves the right to modify the design and/or construction of the fixture shown without further notification.